

General Purpose PNP Epitaxial Planar Transistor

BTP8550A3

Description

The BTP8550A3 is designed for use in output amplifier of portable radios in class B push pull operation.

Features

- Large collector current , $I_C = -1.5A$
- Low $V_{CE(sat)}$
- Complementary to BTN8050A3.

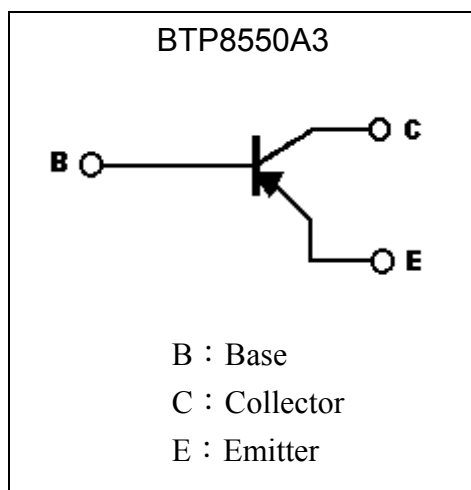
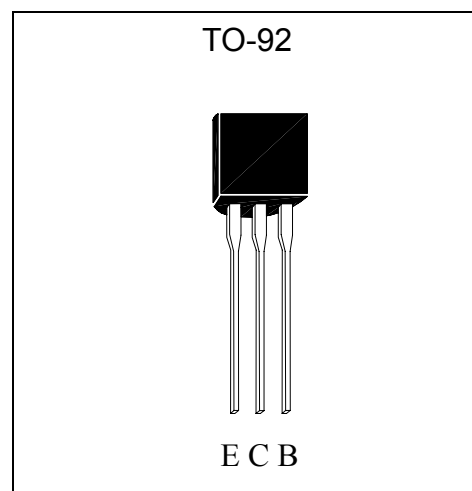
Symbol

Outline

Absolute Maximum Ratings ($T_a = 25^\circ C$)

| Parameter | Symbol | Limits | Unit |
|---|-----------------|----------|--------------|
| Collector-Base Voltage | V_{CB0} | -40 | V |
| Collector-Emitter Voltage | V_{CE0} | -25 | V |
| Emitter-Base Voltage | V_{EB0} | -6 | V |
| Collector Current | I_C | -1.5 | A |
| Base Current | I_B | -0.5 | A |
| Power Dissipation | P_d | 625 | mW |
| Thermal Resistance, Junction to Ambient | $R_{\theta JA}$ | 200 | $^\circ C/W$ |
| Junction Temperature | T_j | 150 | $^\circ C$ |
| Storage Temperature | T_{stg} | -55~+150 | $^\circ C$ |



Characteristics (Ta=25°C)

| Symbol | Min. | Typ. | Max. | Unit | Test Conditions |
|-----------|------|------|------|------|------------------------------|
| BVCBO | -40 | - | - | V | IC=-100μA |
| BVCEO | -25 | - | - | V | IC=-2mA |
| BVEBO | -6 | - | - | V | IE=-100μA |
| ICBO | - | - | -100 | nA | VCB=-35V |
| IEBO | - | - | -100 | nA | VEB=-6V |
| *VCE(sat) | - | - | -0.5 | V | IC=-800mA, IB=-80mA |
| *VBE(sat) | - | - | -1.2 | V | IC=-800mA, IB=-80mA |
| *VBE(on) | - | - | -1 | V | VCE=-1V, IC=-10mA |
| *hFE 1 | 45 | - | - | - | VCE=-1V, IC=-5mA |
| *hFE 2 | 85 | - | 500 | - | VCE=-1V, IC=-100mA |
| *hFE 3 | 40 | - | - | - | VCE=-1V, IC=-800mA |
| fT | 100 | - | - | MHz | VCE=-10V, IC=-50mA, f=100MHz |
| Cob | - | - | 20 | pF | VCB=-10V, f=1MHz |

*Pulse Test: Pulse Width ≤380μs, Duty Cycle≤2%

Classification Of hFE 2

| Rank | B | C | D | E |
|-------|--------|---------|---------|---------|
| Range | 85~160 | 120~200 | 160~320 | 250~500 |

Characteristic Curves

Current Gain vs Collector Current

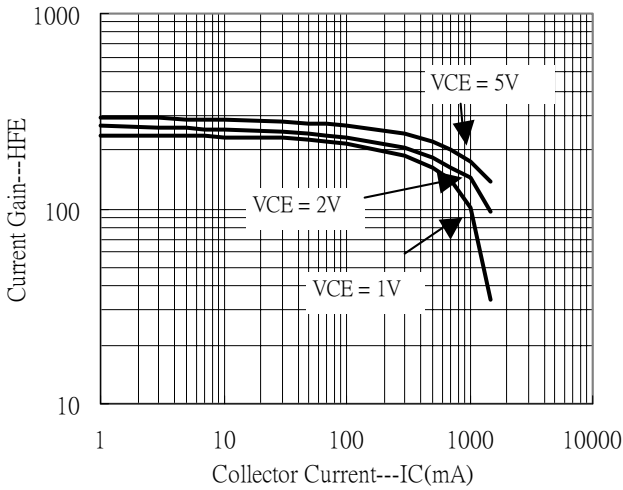

Saturation Voltage vs Collector Current

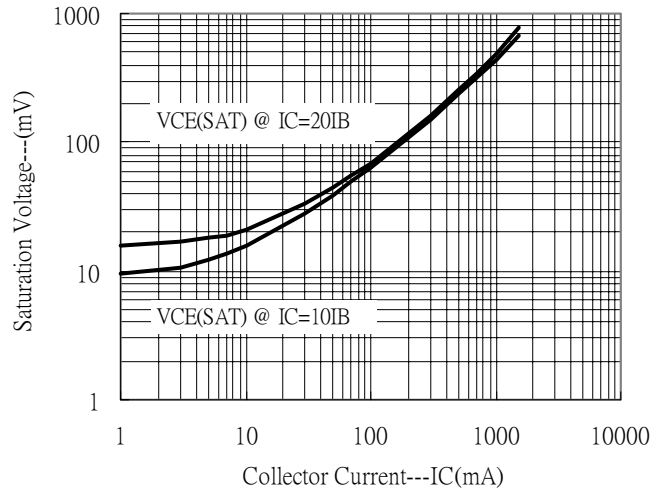

Saturation Voltage vs Collector Current

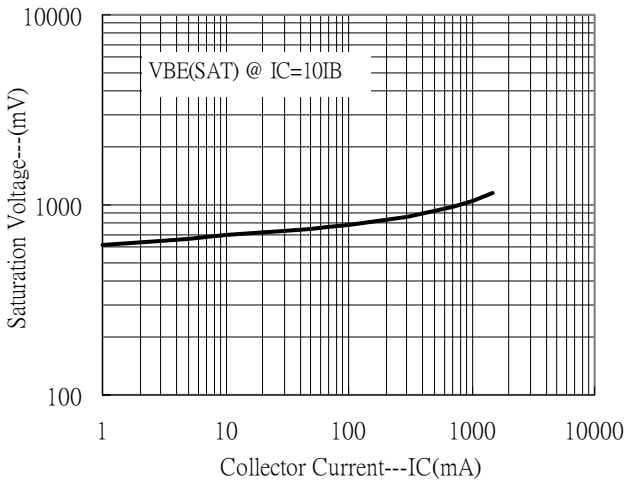

On Voltage vs Collector Current

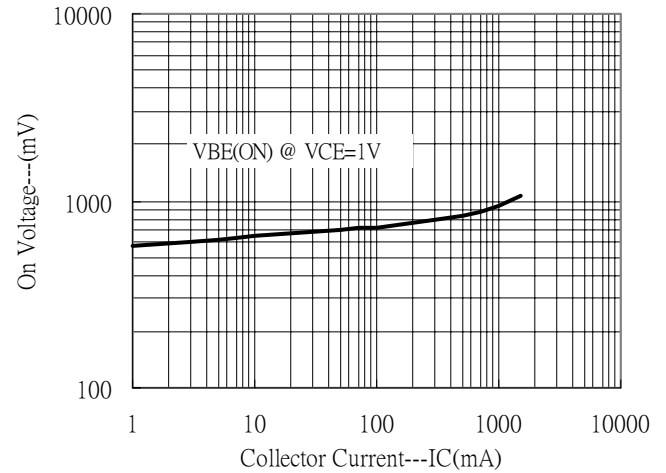

Power Derating Curve

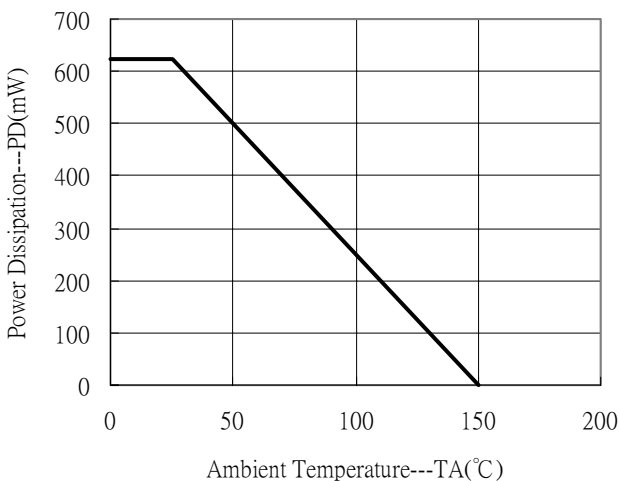

TO-92 Dimension

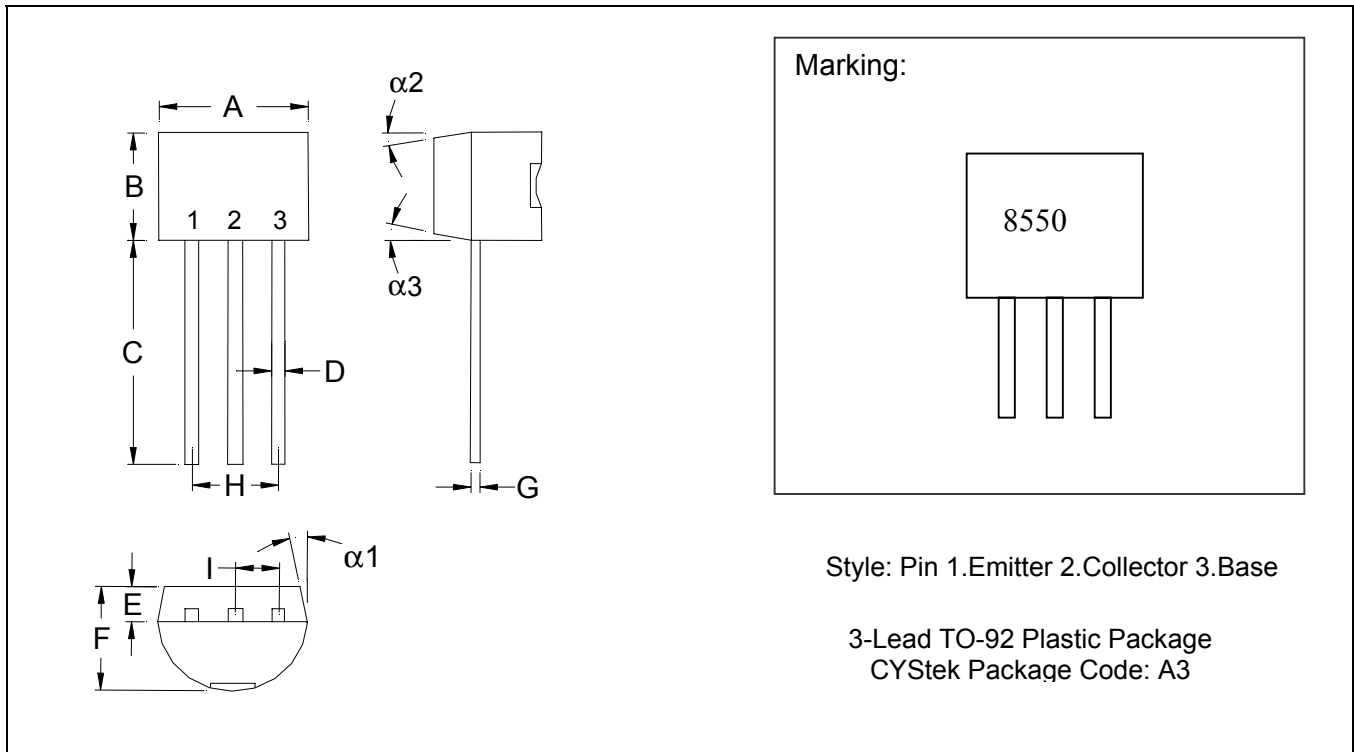

*: Typical

| DIM | Inches | | Millimeters | | DIM | Inches | | Millimeters | |
|-----|--------|---------|-------------|-------|-----|--------|---------|-------------|-------|
| | Min. | Max. | Min. | Max. | | Min. | Max. | Min. | Max. |
| A | 0.1704 | 0.1902 | 4.33 | 4.83 | G | 0.0142 | 0.0220 | 0.36 | 0.56 |
| B | 0.1704 | 0.1902 | 4.33 | 4.83 | H | - | *0.1000 | - | *2.54 |
| C | 0.5000 | - | 12.70 | - | I | - | *0.0500 | - | *1.27 |
| D | 0.0142 | 0.0220 | 0.36 | 0.56 | α1 | - | *5° | - | *5° |
| E | - | *0.0500 | - | *1.27 | α2 | - | *2° | - | *2° |
| F | 0.1323 | 0.1480 | 3.36 | 3.76 | α3 | - | *2° | - | *2° |

Notes: 1. Controlling dimension: millimeters.
 2. Maximum lead thickness includes lead finish thickness, and minimum lead thickness is the minimum thickness of base material.
 3. If there is any question with packing specification or packing method, please contact your local CYStek sales office.

Material:

- Lead: 42 Alloy ; solder plating
- Mold Compound: Epoxy resin family, flammability solid burning class: UL94V-0

Important Notice:

- All rights are reserved. Reproduction in whole or in part is prohibited without the prior written approval of CYStek.
- CYStek reserves the right to make changes to its products without notice.
- CYStek **semiconductor products are not warranted to be suitable for use in Life-Support Applications, or systems.**
- CYStek assumes no liability for any consequence of customer product design, infringement of patents, or application assistance.